

CEMP-ET Engineer Technical Letter 1110-3-456	Department of the Army U.S. Army Corps of Engineers Washington, DC 20314-1000	ETL 1110-3-456 16 August 1994
	Engineering and Design PERMANENT CAMOUFLAGE, CONCEALMENT, AND DECEPTION	
	Distribution Restriction Statement Approved for public release; distribution is unlimited.	

CEMP-ET

DEPARTMENT OF THE ARMY
U.S. Army Corps of Engineers
Washington D.C. 20314-1000

ETL 1110-3-456

Technical Letter
No. 1110-3-456

16 August 1994

Engineering and Design
PERMANENT CAMOUFLAGE, CONCEALMENT, AND DECEPTION

1. Purpose. This letter provides interim guidance for permanent camouflage, concealment, and deception (CCD) measures on military construction projects. The information provided in the enclosure to this letter will enable the designer to apply CCD techniques during facility planning and design.
2. Applicability. This letter applies to all HQUSACE elements, major subordinate commands, districts, and field operating activities (FOA) having military construction design responsibilities.
3. Objective. In the past, when manned attack aircraft flew high and slow, aircrews had an optimum perspective and a relatively long time to visually recognize and acquire targets. Effective CCD then demanded elaborate visual deceptions and comprehensive coverage designed to make the target nearly invisible. Today, attacks are typically executed at low altitudes and high speeds and target recognition and acquisition relies heavily on visual, thermal infrared, and radar imagery. Effective CCD now typically demands less elaborate deceptions. Maximum CCD benefit is gained by incorporating permanent measures during planning and design. Even if add-on CCD measures are deployed during wartime, permanent measures will enhance the effectiveness of the add-on applications.
4. Action. When a design project requires CCD, use the information and guidance provided in the enclosure to this letter.
5. Implementation. This letter will have routine application as defined in paragraph 6c, ER 1110-345-100.
FOR THE DIRECTOR OF MILITARY PROGRAMS:

2 Appendices

APP A - Permanent Camouflage,
Concealment, and Deception
APP B - Bibliography

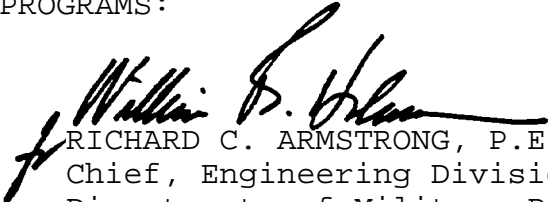
RICHARD C. ARMSTRONG, P.E.
Chief, Engineering Division
Directorate of Military Programs

APPENDIX A

PERMANENT CAMOUFLAGE, CONCEALMENT, AND DECEPTION

1. INTRODUCTION. The basic camouflage, concealment, and deception (CCD) techniques discussed are primarily related to reducing the effectiveness of manned attack aircraft, although many of these techniques also reduce the effectiveness of reconnaissance and surveillance activities. The principal methodology of CCD is to systematically determine what is conspicuous, why it is conspicuous, and how best to reduce the conspicuousness. The major constraints are that CCD measures must not unduly increase facility expense and must not significantly interfere with facility operations.

2. ATTACK AIRCRAFT THREAT AND CCD DEFENSE. A general description of the manned attack aircraft threat and the objective of CCD defense is presented below.

a. Attack Process. A manned attack aircraft can get quite close to the target using navigation alone. However, the crew must still look for an orientation feature or initial point that further identifies the target location in order to initiate the final approach. During the final approach, the crew achieves target recognition or identification, acquires the target with the weapon aiming system, and then launches the weapon. The initial approach is typically performed at low altitude to avoid detection by the defender as shown in figure A-I. The attack aircraft will then often pull up to a higher altitude for more favorable target acquisition and weapon launch. Target recognition and acquisition are typically achieved using aided viewing in the visual, thermal infrared, or radar wavebands.

b. Bomb Delivery. In the case of unguided bombs, several bombs are often released at predetermined intervals to increase the chances that at least one bomb will land on the target. The concept behind guided bombs is that, if placed exactly, one bomb can do as much or more damage than several bombs delivered without deference to where they land in the target area. In the case of laser systems, the target is designated by illumination with a laser beam prior to bomb release and the aircraft range finder then automatically calculates the required trajectory and releases the bomb. During subsequent intermittent or continuous laser designation, the bomb is guided to the target more precisely by a laser guidance package mounted on the bomb nose. Other guidance systems include bomb mounted television cameras and thermal seeking devices. When guided bombs are used, the

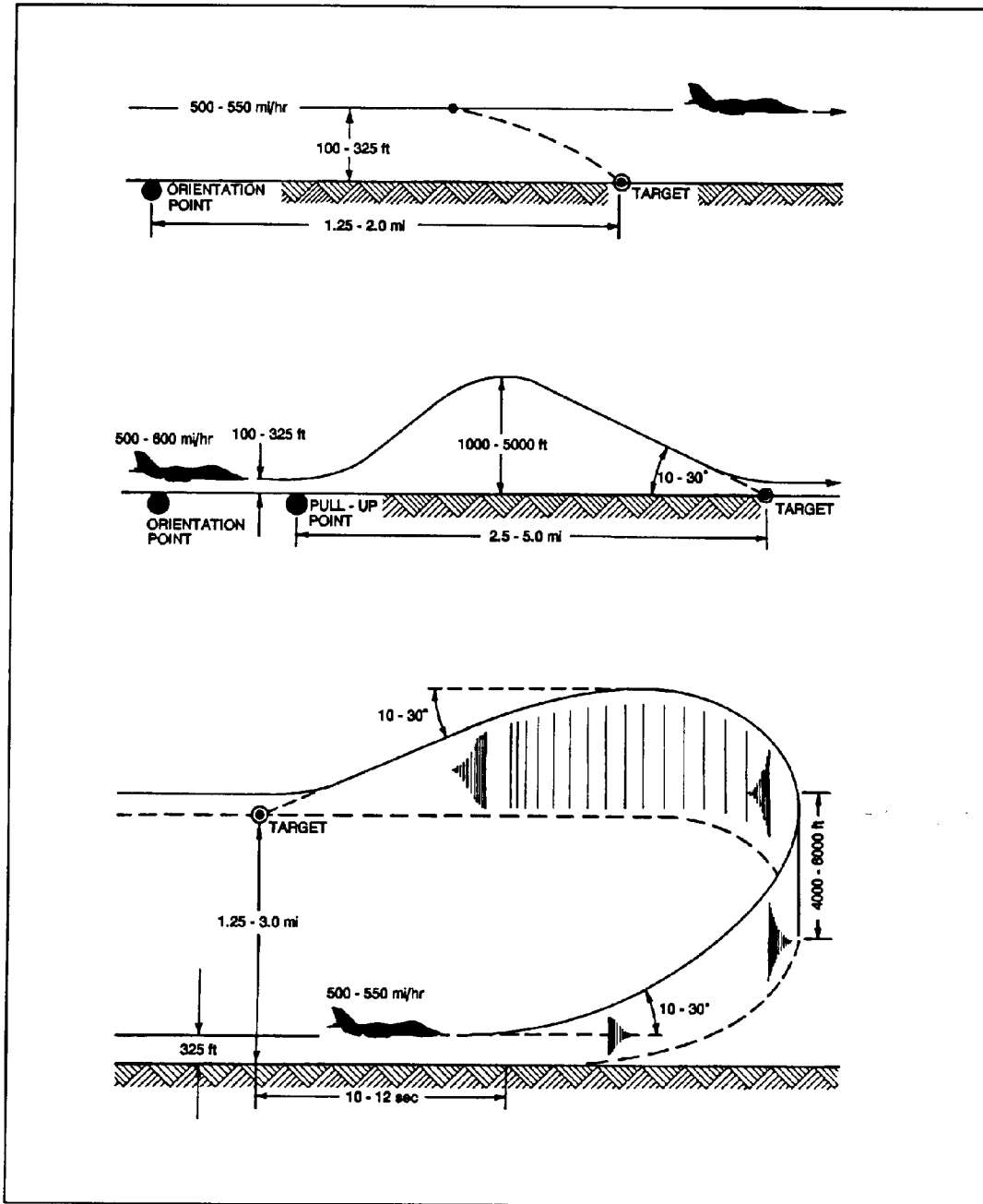

Figure A-1. Typical Manned Aircraft Attack Profiles.

16 Aug 94

attack aircraft crew will usually look for doors, windows, vents, or other soft areas to use as aiming points or will look for aiming points previously identified during reconnaissance or surveillance activities.

c. CCD Defense. The objective of permanent CCD measures is to disrupt or at least slow down the process of attack initiation, target recognition, and target acquisition. If this can be achieved, weapon accuracy is degraded, the attacker is forced to select an alternate and less valuable target, or the attacker is forced to abort weapon launch and initiate a second attack. During a second attack, the element of surprise is lost and the attack aircraft is more vulnerable to air defense weapons. Because attacks are carried out at low altitude and high speed, CCD measures need not make the target invisible. They need only cause momentary doubt or confusion.

3. THREAT DEFINITION. The threat from manned attack aircraft should be defined by the using service in terms of attack profiles, attack directions, imaging and weapon guidance sensors, weapon systems, time of day of attack, and reconnaissance and surveillance capabilities. When possible, information can also be obtained by interviewing local aircrews on how they would execute an attack.

a. Attack Profiles. An attack profile consists of the attack flight path and speed, and it depends mainly on the air defense systems and attack aircraft capabilities. Modern air defense systems usually include radar warning systems and ground-to-air missiles that dictate a low altitude and high speed attack, and most modern attack aircraft have navigation and imaging systems that make this type of attack possible. If specific attack profile information is not available, the typical low altitude attack profiles shown in figure A-1 should be used.

b. Attack Directions. The most likely attack directions include a straight line from a prominent point orientation feature to the target and along linear orientation features such as roads, railroads, runways, and rivers. The attack direction may also coincide with gaps in warning radar coverage or other inherent weaknesses in the air defense system. Specific information on likely attack directions can be obtained from the base operation group, intelligence flight, and weapons flight.

c. Target Acquisition for Bombing. The slant range or aircraft to target slant distance for initializing target acquisition for bombing should be taken as 6,000 to 8,000 feet. This is the typical distance at which target tracking first occurs. To change targets after reaching this slant range would result in

ETL 1110-3-456
16 Aug 94

significant errors in bomb delivery because a stable bombing platform is needed for the few seconds between the initial tracking point and the bomb release point.

d. Sensors. Sensors provide imagery during orientation feature identification, target recognition, and target acquisition, and laser sensors are used as range finders and target designation devices. The most predominant sensor wavebands are the radar, long wave infrared (LWIR), middle wave infrared (MWIR), near infrared (NIR), and visual wavebands shown in figure A-2. The thermal infrared waveband includes both the LWIR and MWIR wavebands. The effect of various atmospheric conditions on sensors operating on various wavebands is shown in table A-I. Sensor systems can be classified as active or passive. Active systems rely on beam propagation and reflection; typically a radar or laser beam. Passive systems produce imagery without beam propagation and typically use thermal infrared or visual light signals. Passive systems cannot be detected because there is no propagated beam to detect.

(1) Radar. Radar beam reflection depends on the surface orientation, the surface roughness, and the surface dielectric constant or conductivity. For example, a steel plate has a high dielectric constant and low roughness and will reflect almost all of the radar beam without scatter. A radar sensor in a low altitude attack aircraft will detect a vertical steel plate as a distinct white area because almost all of the radar beam is reflected back to the aircraft sensor. A horizontal steel plate will be detected as a black area because almost all of the beam is reflected away from the aircraft sensor. Most radar produces a low resolution image that requires training for effective interpretation. The exception is the recently developed millimeter wave radar or high resolution radar.

(2) Thermal Infrared. Thermal infrared sensors produce an image from surface heat emissions. Surface areas that have highly contrasting heat emission properties such as water next to the shoreline, pavement next to grass, and hot vehicle engines will produce clear and obvious images.

(3) Visual. Visual images are produced from light in the visual waveband. Low light systems such as low light television produce images from small light sources such as starlight and are used for night viewing.

(4) Lasers. Lasers are used for range finders and target designation devices. Various laser wavebands and laser types are shown in figure A-3. The average detection ranges

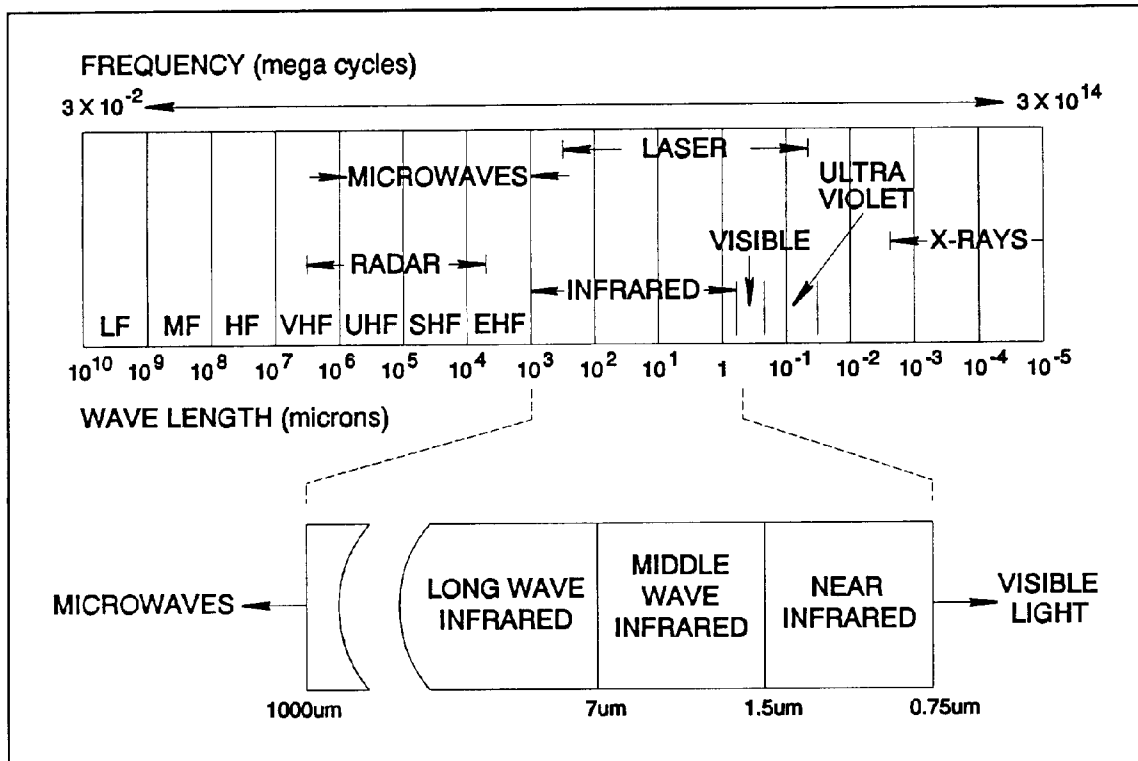

Figure A-2. Major Threat Wavebands.

shown in the figure apply to several different sensor types in each waveband and are based on air-to-ground viewing in a standard clear atmosphere. This figure can be used to determine approximate remote sensing ranges when wavebands or laser types are specified.

e. Weapon Systems. Specific weapon identification and characteristics should be obtained whenever possible. Weapon identification generally gives some insight into the type of target acquisition, the type of guidance system, and the weapon launch ranges that could be used. Weapon characteristics are useful for determining facility separation distances required to force separate attacks and to access the collateral damage from attacks on nearby facilities.

Table A-1. Effects of Various Atmospheric Conditions on Sensors Operating in Major Threat Wavebands.

Atmospheric Parameters	Radar	Thermal Infrared	Thermal Infrared	Visible and Near IR
	Millimeter Wave	Long Wave IR	Middle Wave IR	
Low Visibility	None	Low	Low	Severe
Rain/Snow	Moderate/Low	Moderate	Moderate	Moderate
High Humidity	Low/None	Moderate	Moderate	Low
Fog/Cloud	Moderate/Low	Severe/Moderate	Severe/Moderate	Severe
Phosphorus/Dust	Low/None	Moderate	Severe/Moderate	Severe
Fog Oil/Smoke	None	Low	Low	Severe

f. Time of Day of Attack. The times of day that attacks are expected should be obtained when possible. The time of day will influence which features of a facility are most conspicuous and will help prioritize the various CCD measures. For example, visible shadows would not be the primary concern if only night attacks are expected, but facility surfaces that stay warmer than the surroundings and are detectable by thermal infrared sensors might be a primary concern at night.

g. Reconnaissance and Surveillance. Reconnaissance is the act of obtaining information about the target area prior to or after an attack and is usually accomplished by aerial photography or satellite imagery. Surveillance implies monitoring the target area for long periods and recording pertinent information such as construction layout, ingress and egress activities, communication traffic, and facility function. Surveillance is typically accomplished by aerial photography, satellite imagery, and intelligence gathering.

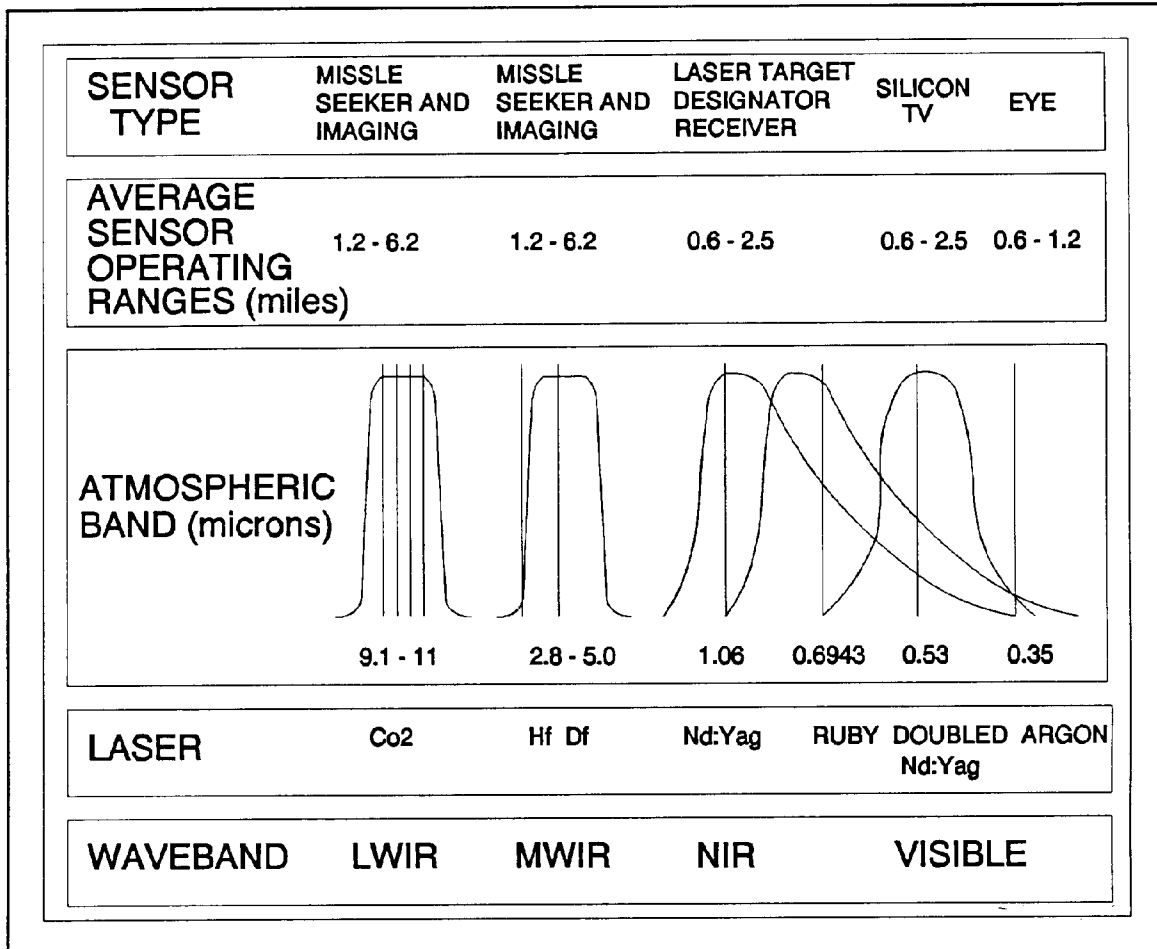

Figure A-3. Major Sensor and Laser Threats to Facilities.

4. PREPARATION AND PLANNING. The incorporation of permanent CCD measures into facility design usually requires a thorough threat definition, a knowledge of base topography, identification of possible attack orientation features, identification of critical base assets, a site visit, and coordination with add-on CCD measures deployed during wartime.

a. Base Topography. The sources of topographic information required for CCD planning include regional maps, an up-to-date base site plan or base map, and aerial photographs. Regional maps are used to locate orientation features an attacker might use and to locate natural obstructions that could be used for

16 Aug 94

concealment. Base site plans are used to locate local orientation features, critical assets, and candidate facility sites. Aerial photographs will give the view that an attack aircraft might have of a base and are essential to proper planning and design. Photographs should overlap at least 60 percent and include oblique photographs taken along likely attack directions and angles. Aerial imagery in the visual spectra and all infrared and radar spectra stated in the design threat are recommended.

b. Identification of Attack Orientation Features. The base and surrounding topography should be examined to determine which existing reference points an attack aircraft might use to locate the target. Orientation features include highways, railroad tracks, road intersections, rivers, characteristic landforms such as knolls, and isolated structures such as towers, poles, and bridges.

c. Critical Asset Identification. Critical asset identification is required when dispersal is to be considered. Critical assets are base assets that contribute to base war-fighting capabilities. Each critical asset location should be color marked on the base site plan. If possible, critical assets should be categorized according to target value with different colors assigned to each target category. A comprehensive list of critical assets that reflects the base wartime configuration should be obtained when possible. Airbase critical assets will normally include control centers, communication facilities, squadron operation facilities, aircraft engine repair shops, avionics shops, precision measurement equipment laboratory or PMEL facilities, aircraft hangars, aircraft shelters, open aircraft parking areas, runways, control towers, jet fuel storage and dispensing facilities, munitions storage areas, electrical switching stations, fire stations, ground radar systems, and ground-to-air weapon systems.

d. Site Visits. A site visit is required to validate attack orientation features and critical assets and to evaluate the project site.

e. Coordination With Add-On CCD Measures. The add-on CCD measures to be deployed during wartime should be thoroughly investigated to ensure that permanent measures effectively complement add-on measures. The requirements for permanent measures may be as simple as providing roof attachments for rapid deployment of nets or masking thermal infrared signatures to complement nets that are only effective against visual and radar viewing.

16 Aug 94

5. SITE SELECTION. The proper siting of a facility can be of enormous value for improving survivability through CCD. The effective use of terrain and natural cover to prevent the attacker from viewing the target has been a major CCD measure used throughout history. By using topography to obscure the view along probable attack avenues and natural vegetation for hiding structures, targeting cues are drastically reduced. The general guidelines indicated below should be followed.

a. Avoid Orientation Features. Whenever possible, facilities should not be built near easily identifiable cultural or natural features such as lakes, rivers, towns, crossroads, monuments, etc. It is probably not practical to build a facility without nearby roads, rivers, railroads, etc.; however, whenever possible these should be avoided because they are easily followed to the target area. The designer must also be careful not to worsen the problem by adding new orientation features.

b. Select Complex Terrain Patterns. When possible, the facility should be placed in a region exhibiting a complex terrain pattern, rather than a simple or relatively featureless terrain as shown in figures A-4 and A-5. When a simple terrain is the only option, use local vegetation to conceal the facility as shown in figure A-6.

c. Select a Concealed Location. Study the base terrain features and try to locate facilities so that they are obscured or partially obscured by the terrain. For example, locate the facility in and around tall trees, rock formations, and hills or locate the facility in a dry ravine where no danger of flooding exists and adequate drainage is available.

d. Avoid Regular Building Patterns. While facilities laid out in a regular pattern or gridwork are standard in military construction, they also represent a key targeting cue to an attack aircraft. Fit facilities into the natural topography and vegetation and avoid regular patterns.

e. Utilize Dispersal. If possible, facilities that could be valuable targets should be dispersed so that they must be attacked separately.

6. CONSPICUOUS FEATURES. Conspicuous building features that should be avoided or properly oriented are described below.

a. Right Angles and Vertical Surfaces. Right angles and vertical surfaces actively promote detection. Right angles are sources of strong radar returns, and vertical surfaces are observed by the shadows they create and the strong thermal

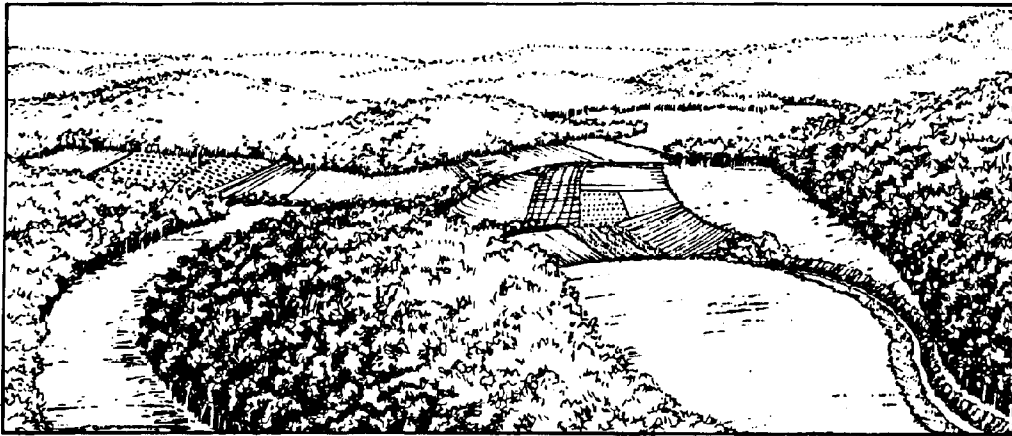

Figure A-4. Complex Terrain Pattern.

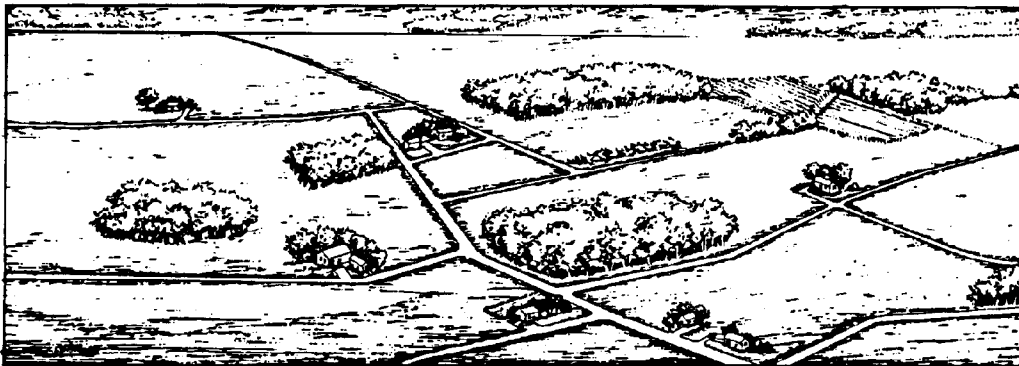

Figure A-5. Relatively Simple Terrain Pattern.

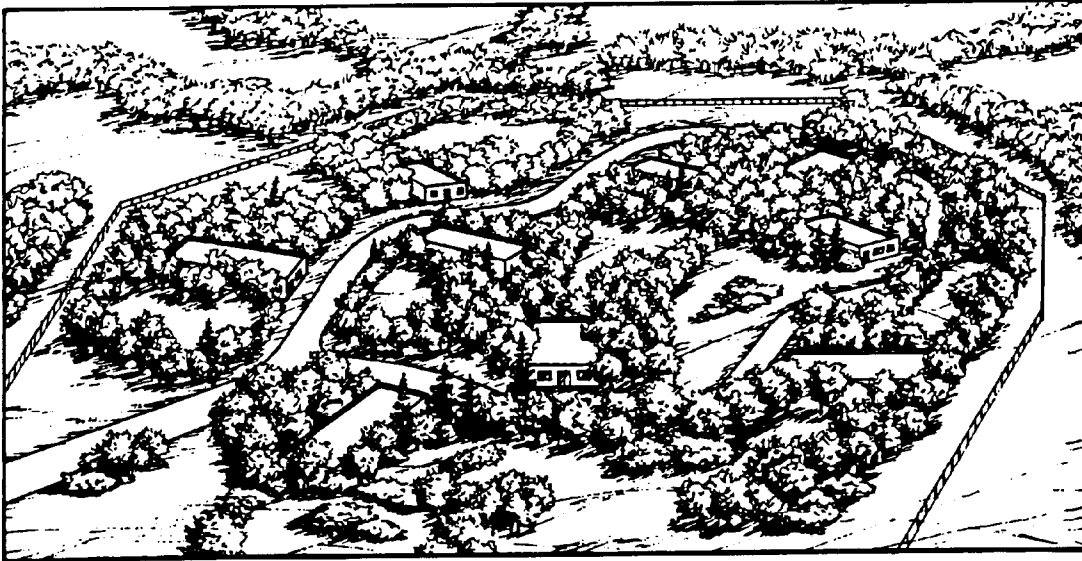

Figure A-6. Use of Trees for Camouflage.

infrared contrast with the surroundings. Right angles can be avoided by sloping exterior walls or placing earth berms around the perimeter of the structure. If vertical exterior surfaces must be used, trees and shrubbery should be planted, as a minimum, on the east and west sides of structures and close enough to prevent direct solar radiation from falling on the walls.

b. Metal Siding and Roof Decks. Metal siding and roof decks are large radar reflectors. Refrain from using exterior metal surfaces.

c. Exposed Steel Framing. Exposed steel framing should be round and not angular. Radar beams reflect off of the multiple surfaces of exposed wide flange, channel, and angle shapes and then present a large, easily recognizable radar signature.

d. Eaves and Cornices. Eaves and cornices should not utilize right angle interfaces or re-entrant corners.

e. Windows. Windows should be avoided or the number of windows should be kept to a minimum. Radar beams enter through windows and reflect off of the right angles within the room. A strong component of the reflected beam will then exit the window as a large radar signature. Metal window frames should be avoided because of the large radar reflectance.

ETL 1110-3-456
16 Aug 94

f. Doors. Metal doors, especially large metal overhead doors or roll-up doors are large radar reflectors and open doors produce a large radar signature similar to that of windows.

g. Exhaust Vents. Exhaust vents create a signature that is easily seen by thermal infrared viewing. The signature is created by pipes, louvers, and other surfaces that are heated by the exhaust. The hot exhaust gases are not easily detected.

h. Cooling Towers. The use of cooling towers should be avoided because under some atmospheric conditions they create condensation clouds that can be seen from large distances.

7. CAMOUFLAGE AND CONCEALMENT MEASURES. General camouflage and concealment measures to be considered in the design of facilities with manned attack aircraft threats are discussed below. These measures generally consist of reducing conspicuousness or orienting conspicuous features away from the most likely attack avenues or toward natural obstructions such as mountain ridges, hills, or tall trees to avoid direct line-of-sight viewing by attack aircraft.

a. Site Preparation. Clearing and grading of natural vegetation should be kept to a minimum. When facilities are constructed in forested areas, as much of the original foliage as possible should be left in place. If large forested areas must be cleared, reforestation should take place as soon as possible to replace the natural foliage.

b. Blending With Surroundings. If possible, the facility should blend with the surroundings so that it is hard to tell from the air where the facility begins and ends. This can mean blending with adjacent terrain or imitating or joining adjacent buildings. Samples of blending site terrain features are shown in figures A-7 and A-8. A sample of blending a partially buried facility with surrounding topography and foliage is shown in figure A-9. Avoid the use of uniform surfacing materials such as bare ground, paving, and grass that contrast with the structure. When the close proximity of existing facilities prevents blending with the terrain, use the same architecture as the nearby facilities; e.g., use the same color, patterns, and roof style.

c. Soil and Foliage Cover. Soil and foliage are among the most effective cover treatments because they reduce the effectiveness of all viewing; i.e., visual, infrared, and radar. However, these cover treatments can still make a facility conspicuous when the nearby surroundings are not considered. For example, an isolated group of trees can be conspicuous when placed in the middle of several buildings.

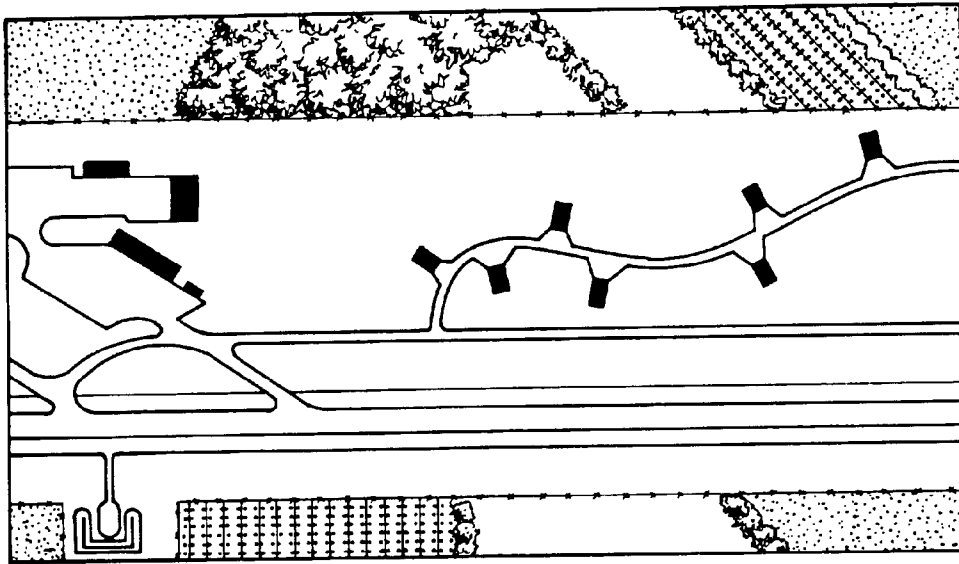

Figure A-7. Use of Very Little Vegetation.

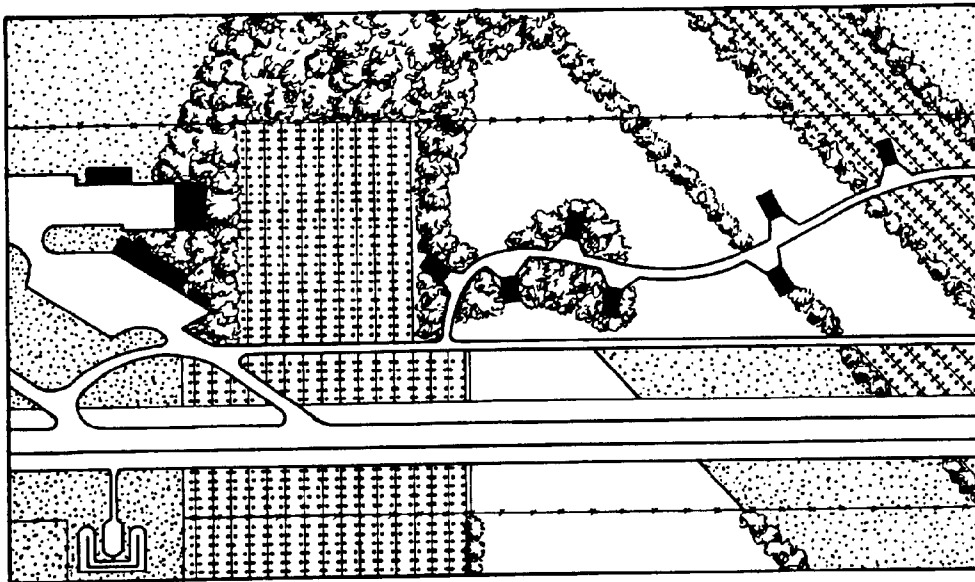

Figure A-8. Use of Vegetation Patterning to Imitate Surrounding Patterns.

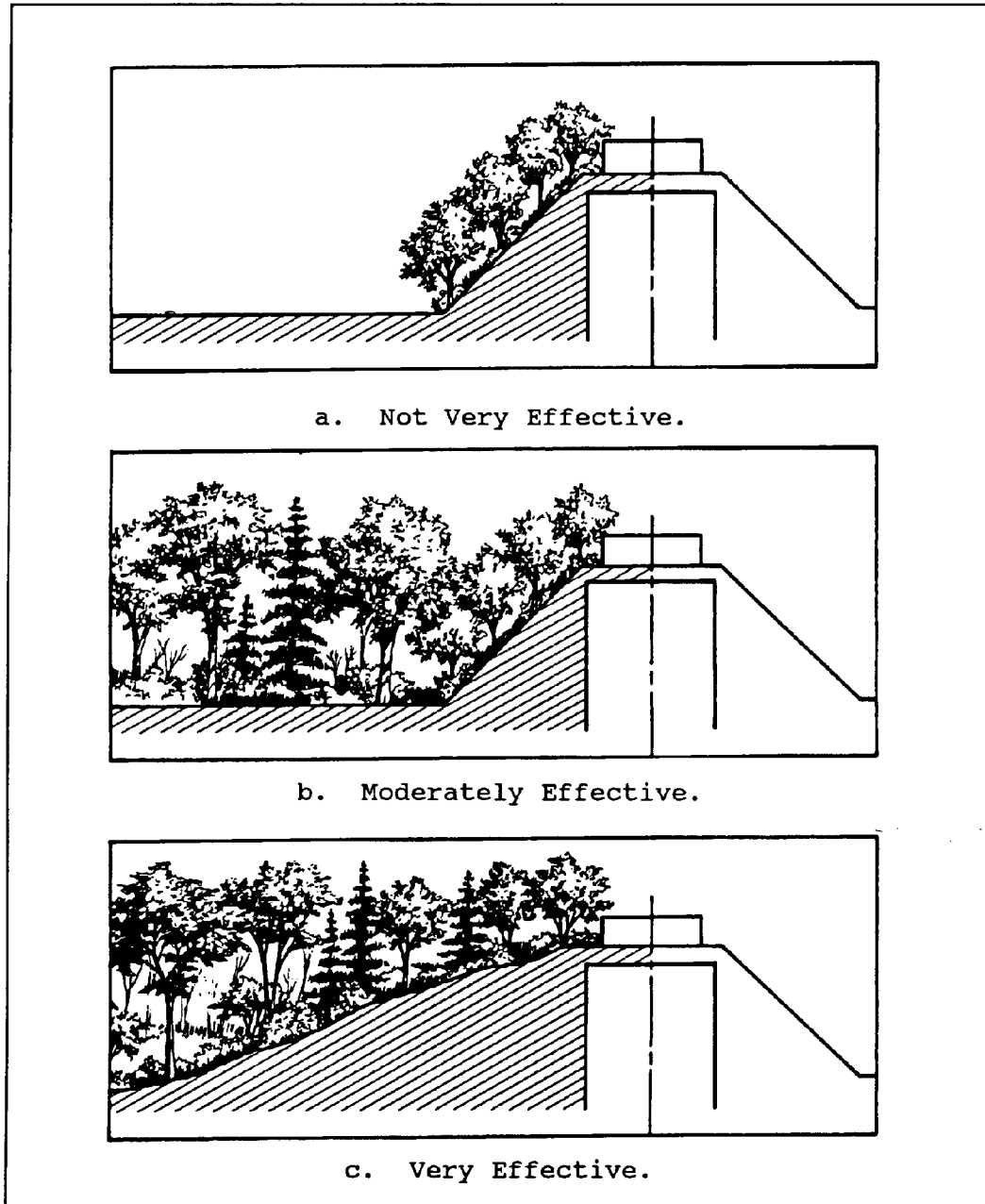

Figure A-9. Samples of Camouflage by a Soil Embankment Supplemented With Trees and Bushes.

16 Aug 94

d. Buried Structures. Buried structures should keep the covering mound as low as possible and planting materials local to the immediate surroundings should be used on the mound. Refrain from planting foliage that is different from the surroundings. The entrances to belowground structures should be concealed or oriented as much as possible away from attack avenues and toward line-of-sight obstructions. These openings are generally cooler than the surroundings and present a strong thermal infrared signature that is easy to identify from the air.

e. Surface Structures. The following measures will reduce the target detection range of surface structures.

(1) Structure Height. Tall structures are easier to find during a low altitude approach, and the shadows they produce make them more visible from all altitudes. Single story structures are preferable and should be kept as low as possible.

(2) Structure Size. Structures should be kept as small as possible to reduce target size. Multiple, dispersed, small structures are preferable to one large structure.

(3) Structure Orientation. Present the smallest aspect to the attacker. The smallest structure face should be oriented toward likely attack avenues. Large structure faces should be oriented away from attack avenues or toward line-of-sight obstructions.

f. Conspicuous Features. If conspicuous building features such as windows, doors, driveways, and vents cannot be avoided, they should be confined to one side of the building and, if possible, oriented away from attack avenues and toward line-of-sight obstructions. Even if the attack avenue is unknown, at least the building is only conspicuous in one direction rather than several. The remainder of the building surfaces should utilize blending or at least be made as featureless as possible.

g. Feature Deceptions. Care should be taken to ensure that any deceptions applied to buildings are effective in all specified viewing spectra. For example, a false window can be made to have the same visual signature as a real window, but the thermal infrared and radar signatures could be very different from that of a real window. The same problem occurs when metal siding is color treated to look like concrete.

h. Utilities and Equipment. Utility service lines should be belowground. Long runs of isolated aerial electrical service should be avoided. Wartime equipment such as power generation equipment and air-cooled condensers should be located inside.

ETL 1110-3-456
16 Aug 94

This equipment creates hot spots that are easily seen by thermal infrared viewing.

i. Reconnaissance and Surveillance. If significant reconnaissance and surveillance threats are to be neutralized, the CCD measures are generally more elaborate. Effective CCD will then commonly include add-on camouflage and decoys deployed during wartime. These measures are usually intended to confuse the attacker by making the target area appear different during the attack than it did during reconnaissance and surveillance.

j. Permanent Decoys. The objective of decoys is to create false targets that simulate high-value assets. The general strategy is to reduce the likelihood that high-value assets will be attacked by causing the attacker to expend resources on the decoys. Permanent decoys have not been used often. The problems are that the decoy must be durable, simulate the high-value asset in all specified viewing spectra, and deceive any reconnaissance and surveillance activities. Also, once the decoy is attacked and destroyed, its usefulness is over. This creates a demand for low cost that generally cannot be met by permanent decoys.

8. COATINGS. Coating types, benefits, and availability are summarized in table A-2. Coatings that keep visual signatures to a minimum should be selected. Radar absorbing coatings are under development but are not yet available for construction projects.

a. Concrete Dye. A dye mixture that blends the color of the concrete with the surrounding soil or foliage should be used. Rough surfaces always present a better match for natural surroundings and smooth concrete surfaces should be avoided.

b. Paint Colors. Paints applied to structures should blend with the surroundings as much as possible. The use of silver or white paint should be avoided, especially on large structures.

Table A-2. Summary of Coating Types, Benefits, and Availability.

Coating Type	Visual	Thermal	Radar	Availability	Remarks
Tonedown Stain	Darkens surfaces to reduce brightness; no color matching	No benefit; increases thermal contrast on sunny days	No benefit	Commercial; used for NATO tone-down program	Manganese-based stain works only on concrete surfaces
Camouflage Paints	Color matching; brightness reduction; patterning using multiple colors	Little benefit	No benefit	Commercial; military DOD stock items	Large variety available; some easily removed using solvents
Low-Emissivity Paints	Brightness reduction; color matching if correct pigments are used	Contrast reduction for hot and warm targets; patterning and shape disruption	No benefit	Prototype material	Can create large negative thermal contrast if used in cool (ambient) temperature surfaces
Pigmented Epoxy Emulsions	Excellent color matching possible; durable on trafficked surfaces; may have glossy appearance	Possible reduction in solar energy absorption causing some contrast reduction	No benefit	Commercial	Substitute for camouflage paints; any color possible; durable for pavements
Urethane Emulsions	Excellent color matching by use of natural soil mixed in surface of coating; good for patterning	Possible solar energy absorption control to reduce contrast on sunny days; no impact at night	No benefit	Commercial (prototype)	Good visual benefits; expensive for large areas; durability on trafficked surfaces needs testing
Radar Absorbing Paints	Can be pigmented to match visual background reflectances	Unknown	Absorption of specific frequencies	Commercial (prototype)	

APPENDIX B

BIBLIOGRAPHY

Camouflage Research Team, Ft. Belvoir Research Development and Engineering Center (1992), "Comparative Market Survey for High Mobility Camouflage Systems," Ft. Belvoir, VA.

Curtis, John O., "A Conceptual Approach for Fixed Facility Camouflage," Miscellaneous Paper EL-91-19, U.S. Army Engineer Waterways Experiment Station, Vicksburg, MS.

Department of the Army (1989), "Camouflage," Field Manual (FM) 20-3, Washington, DC.

Department of the Army (1978), "Tactical Deception," Field Manual (FM) 90-2, Washington, DC.

Duke, Jonathan C., Jr.; Durst, Bartley P.; Meeker, David L.; and Velazquez, Gerardo I., "Considerations for Preparing Camouflage, Concealment, and Deception (CCD) Installation Guidance," Miscellaneous Paper EL-92-1, U.S. Army Engineer Waterways Experiment Station, Vicksburg, MS.

Engdahl, T.L. (1976), "Camouflage Materials for Fixed-Installation Concealment," Miscellaneous Paper M-76-21, U.S. Army Engineer Waterways Experiment Station, Vicksburg, MS.

Florence, W.E. and Wiant, F.W., "Airland Battle Survivability and Camouflage, Phase 1: An Assessment of the U.S. Army Camouflage Program (U)," U.S. Army Corps of Engineers, Engineer Studies Center, Fort Leonard Wood, MO.

Gladen, Curtis L. (1985), "Thermal Camouflage of Fixed Installations (U); Report 1: Spectral Reflectance Measurements of Thermal Camouflage Materials (U)," Technical Report EL-85-4, U.S. Army Engineer Waterways Experiment Station, Vicksburg, MS.

Link, L.E.; Curtis, J.O.; and Willhouse, D. (1985), "Airbase Camouflage Techniques," Technical Report EL-85-2, U.S. Army Engineer Waterways Experiment Station, Vicksburg, MS.

Rosa, Stephen P.; Durst, Bartley P.; and Velazquez, Gerardo I. (1992), "Contribution of Camouflage, Concealment, and Deception Countermeasures to Passive Defense of War-Critical Facilities of the Continental United States," Technical Report EL-92-39, Monterey Bay Corporation, Columbia, MD and U.S. Army Engineer Waterways Experiment Station, Vicksburg, MS.

ETL 1110-3-456
16 Aug 94

Williams, R.R.; Wheeler, T.R.; and Hubner, G. (1993), "Air Base CCD Guide," Technical Report JCCD-93-2, Office of the Secretary of Defense, Joint Camouflage Concealment and Deception, Joint Test Force; U.S. Army Engineer Waterways Experiment Station, Vicksburg, MS.